

1591C ENCLOSURE

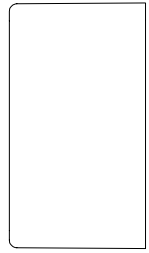

SIDE VIEW OF BOX

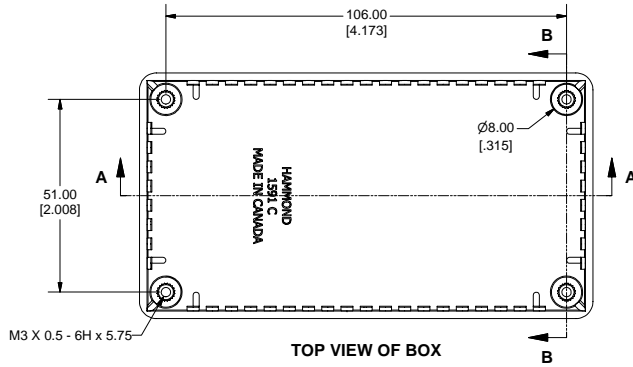

TOP VIEW OF BOX

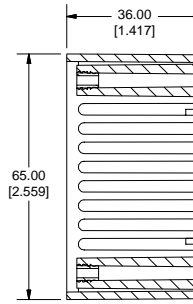

SECTION B-B

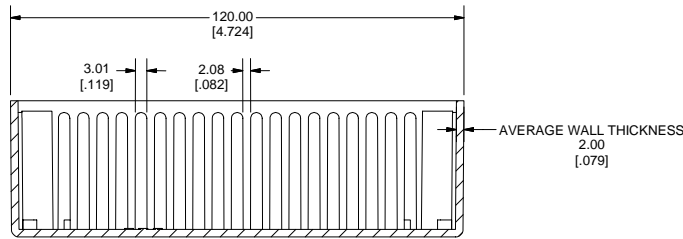

SECTION A-A

Brass Inserts in FRABS and Polycarb
No inserts in GPABS

LID FASTENERS
M3 x 10 mm Screws for FRABS/Polycarb
#4 x 1/2" Self Tapping for GPABS

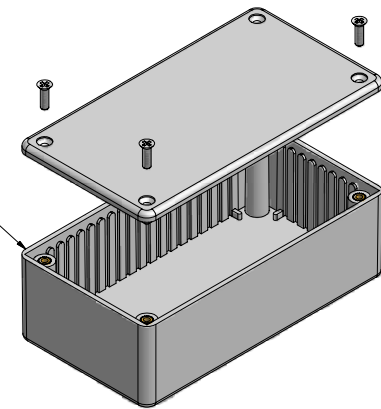

EXPLODED VIEW OF ENCLOSURE

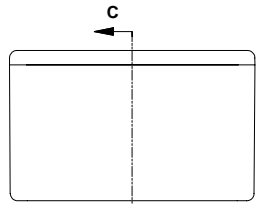

END VIEW OF ASSEMBLY

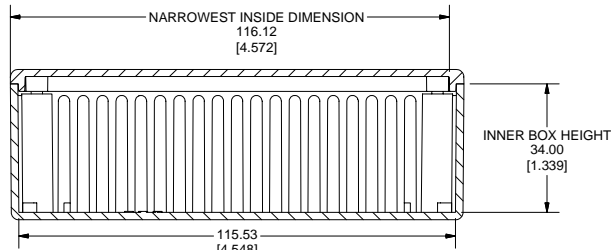

SECTION C-C

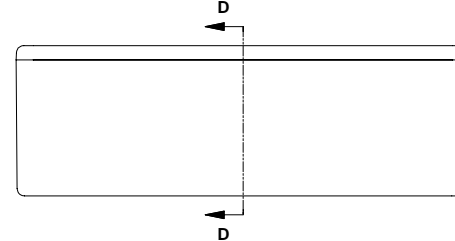

SECTION D-D

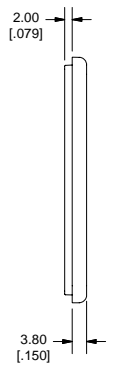

SIDE OF LID

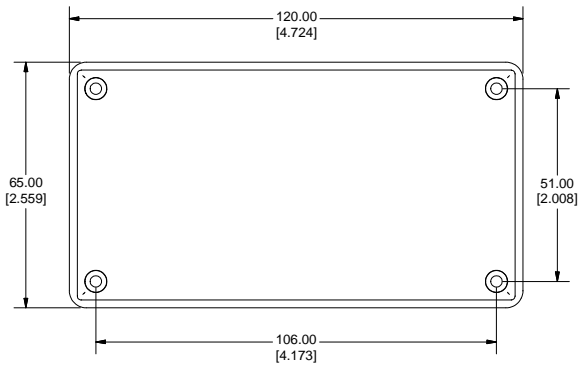

BOTTOM OF LID

Note:

Enclosures can be Factory Modified (Milling, Drilling, Printing etc.)
Solid models of this enclosure available in STEP or IGES Format.
Contact Factory mjm@hammondmfg.com



PART NUMBERS		
1591C Enclosures		
Material	Colour	Part Number
FR ABS	Black	1591CBK
	Grey	1591CGY
UL94 - V0	Black Shielded (Conductive Paint)	1591RCBK
	Black	1591CSBK
GP ABS	Black	1591CSBK
	Grey	1591CSGY
Translucent Polycarbonate	Ice Blue	1591CTBU
	IR Red	1591CTRD
	Crystal Clear	1591CTCL
Accessories		
	Description	Part Number
Universal Application	PC Board Card Adapters	See Accessories Section
	Flange Kits	See Accessories Section
	Clear Lids - clear, flame retardant polycarbonate - Lid ONLY	1591CC
FR ABS & Polycarbonate	Replacement Screws, Flat head Phillips, Nickel Plated Pkg of 100	1591MS100
	Self Tapping Pkg of 100	1591TS100BK (Black) 1591TS100
GP ABS	Self Tapping Pkg of 100	1591TS100BK (Black)
Required Torque on Fasteners (no lubrication)		
	M3 - 0.5 x 10mm Screws	30-40 cN*m
	#4 x 0.5 Screws	30-40 cN*m