

PACKAGE DIMENSIONS

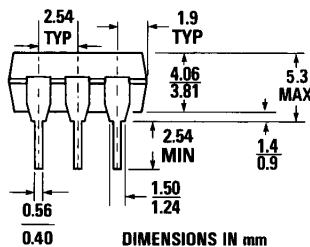

DIMENSIONS IN mm
PACKAGE CODE K

ST1603A

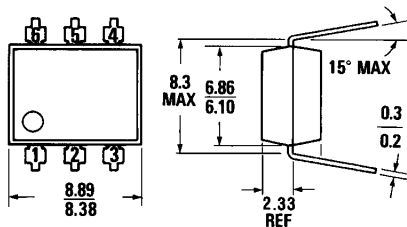
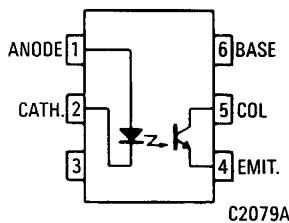

Equivalent Circuit

DESCRIPTION

The MOC series consists of a Gallium Arsenide IRED coupled with an NPN phototransistor.

FEATURES

- High isolation voltage
5300 VAC RMS—1 minute
7500 VAC PEAK—1 minute
- High BV_{CEO} minimum 70 volts
- Current transfer ratio in selected groups:
MOC8111: 20% min.
MOC8112: 50% min.
MOC8113: 100% min.
- Maximum switching time in saturation specified
- Underwriters Laboratory (UL) recognized File #E90700

APPLICATIONS

- Power supply regulators
- Digital logic inputs
- Microprocessor inputs
- Appliance sensor systems
- Industrial controls

ABSOLUTE MAXIMUM RATINGS

TOTAL PACKAGE

Storage temperature	−55°C to 150°C
Operating temperature	−55°C to 100°C
Lead temperature (soldering, 10 sec)	260°C
Total package power dissipation @ 25°C (LED plus detector)	260 mW
Derate linearly from 25°C	3.5 mW/°C

INPUT DIODE

Forward DC current	90 mA
Reverse voltage	6 V
Peak forward current (1 μ s pulse, 300 pps)	3.0 A
Power dissipation 25°C ambient	135 mW
Derate linearly from 25°C	1.8 mW/°C

OUTPUT TRANSISTOR

Power dissipation @ 25°C	200 mW
Derate linearly from 25°C	2.67 mW/°C



PHOTOTRANSISTOR OPTOCOUPERS

ELECTRO-OPTICAL CHARACTERISTICS (25°C Temperature Unless Otherwise Specified)

INDIVIDUAL COMPONENT CHARACTERISTICS

CHARACTERISTIC	SYMBOL	MIN.	TYP.	MAX.	UNITS	TEST CONDITIONS
INPUT DIODE						
Forward voltage	V_F		1.3	1.50	V	$I_F=60\text{ mA}$
Forward voltage temp. coefficient	$\frac{\Delta V_F}{\Delta T_A}$		-1.8		mV/°C	
Reverse voltage	V_R	6.0	15		V	$I_R=10\ \mu\text{A}$
Junction capacitance	C_J		50		pF	$V_F=0\text{ V}, f=1\text{ MHz}$
			65		pF	$V_F=1\text{ V}, f=1\text{ MHz}$
Reverse leakage current	I_R		.35	10	μA	$V_R=3.0\text{ V}$
OUTPUT TRANSISTOR						
Breakdown voltage						
Collector to emitter	BV_{CEO}	70			V	$I_C=1.0\text{ mA}, I_F=0$
Emitter to collector	BV_{ECO}	7			V	$I_E=100\ \mu\text{A}, I_F=0$
Leakage current						
Collector to emitter	I_{CEO}		5	50	nA	$V_{CE}=10\text{ V}, I_F=0$
Capacitance						
Collector to emitter			8		pF	$V_{CE}=0, f=1\text{ MHz}$

TRANSFER CHARACTERISTICS

DC CHARACTERISTICS	SYMBOL	MIN.	TYP.	MAX.	UNITS	TEST CONDITIONS
Current Transfer Ratio, collector to emitter	CTR				%	$I_F=10\text{ mA}; V_{CE}=5\text{ V}$
MOC8111		20				
MOC8112		50				
MOC8113		100				
Saturation voltage	$V_{CE(SAT)}$		0.27	.40	V	$I_F=10\text{ mA}; I_C=2.5\text{ mA}$

TRANSFER CHARACTERISTICS

AC CHARACTERISTICS	SYMBOL	MIN.	TYP.	MAX.	UNITS	TEST CONDITIONS
SWITCHING TIMES						
Non-saturated						$R_L=100\ \Omega; I_C=2\text{ mA}; V_{CC}=10\text{ V}$
Turn-on time	t_{on}		6.0	10	μs	
Turn-off time	t_{off}		5.5	10	μs	See Fig. 10.

ELECTRO-OPTICAL CHARACTERISTICS (25°C Temperature Unless Otherwise Specified) (Cont'd)

TRANSFER CHARACTERISTICS (Cont'd)

AC CHARACTERISTICS	SYMBOL	MIN.	TYP.	MAX.	UNITS	TEST CONDITIONS
SATURATED SWITCHING TIMES						
Turn-on time	t_{on}					
MOC8111			3.0	5.5	μ S	$I_F=20$ mA, $V_{CE}=0.4$ V
MOC8112, MOC8113			4.2	8.0	μ S	$I_F=10$ mA, $V_{CE}=0.4$ V
Rise-time	t_r					
MOC8111			2.0	4.0	μ S	$I_F=20$ mA, $V_{CE}=0.4$ V
MOC8112, MOC8113			3.0	6.0	μ S	$I_F=10$ mA, $V_{CE}=0.4$ V
Turn-off time	t_{off}					
MOC8111			18	34	μ S	$I_F=20$ mA, $V_{CE}=0.4$ V
MOC8112, MOC8113			23	39	μ S	$I_F=10$ mA, $V_{CE}=0.4$ V
Fall-time	t_f					
MOC8111			11	20	μ S	$I_F=20$ mA, $V_{CE}=0.4$ V
MOC8112, MOC8113			14	24	μ S	$I_F=10$ mA, $V_{CE}=0.4$ V

ISOLATION CHARACTERISTICS

CHARACTERISTICS	SYMBOL	MIN.	TYP.	MAX.	UNITS	TEST CONDITIONS
Isolation voltage	V_{iso}	5300			V_{AC} RMS	$I_{iO} \leq 1$ μ A, 1 minute
	V_{iso}	7500			V_{AC} PEAK	$I_{iO} \leq 1$ μ A, 1 minute
Isolation resistance	R_{iso}	10^{11}			ohms	$V_{iO}=500$ VDC
Isolation capacitance	C_{iso}		0.5		pF	$f=1$ MHz

ELECTRICAL CHARACTERISTIC CURVES (25°C Free Air Temperature Unless Otherwise Specified)

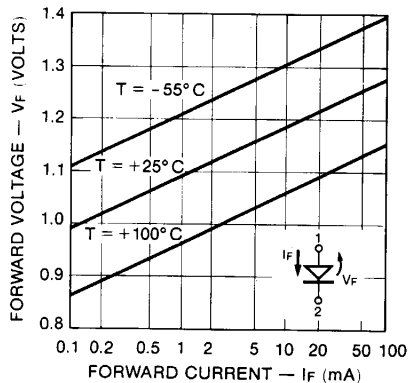

Fig. 1. Forward Voltage vs. Current

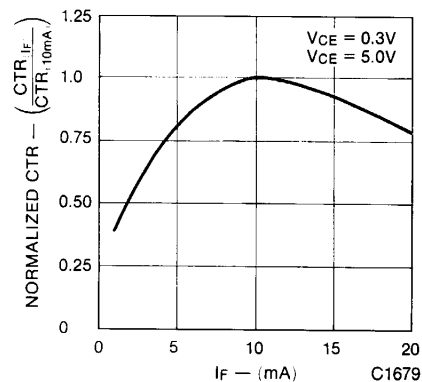

Fig. 2. Normalized CTR vs. Forward Current

ELECTRO-OPTICAL CHARACTERISTICS (25°C Temperature Unless Otherwise Specified) (Cont'd)

TRANSFER CHARACTERISTICS (Cont'd)

AC CHARACTERISTICS	SYMBOL	MIN.	TYP.	MAX.	UNITS	TEST CONDITIONS
SATURATED SWITCHING TIMES						
Turn-on time	t_{on}					
MOC8111			3.0	5.5	μ S	$I_F=20$ mA, $V_{CE}=0.4$ V
MOC8112, MOC8113			4.2	8.0	μ S	$I_F=10$ mA, $V_{CE}=0.4$ V
Rise-time	t_r					
MOC8111			2.0	4.0	μ S	$I_F=20$ mA, $V_{CE}=0.4$ V
MOC8112, MOC8113			3.0	6.0	μ S	$I_F=10$ mA, $V_{CE}=0.4$ V
Turn-off time	t_{off}					
MOC8111			18	34	μ S	$I_F=20$ mA, $V_{CE}=0.4$ V
MOC8112, MOC8113			23	39	μ S	$I_F=10$ mA, $V_{CE}=0.4$ V
Fall-time	t_f					
MOC8111			11	20	μ S	$I_F=20$ mA, $V_{CE}=0.4$ V
MOC8112, MOC8113			14	24	μ S	$I_F=10$ mA, $V_{CE}=0.4$ V

ISOLATION CHARACTERISTICS

CHARACTERISTICS	SYMBOL	MIN.	TYP.	MAX.	UNITS	TEST CONDITIONS
Isolation voltage	V_{iso}	5300			V_{AC} RMS	$I_{iO} \leq 1$ μ A, 1 minute
	V_{iso}	7500			V_{AC} PEAK	$I_{iO} \leq 1$ μ A, 1 minute
Isolation resistance	R_{iso}	10^{11}			ohms	$V_{iO}=500$ VDC
Isolation capacitance	C_{iso}		0.5		pF	$f=1$ MHz

ELECTRICAL CHARACTERISTIC CURVES (25°C Free Air Temperature Unless Otherwise Specified)

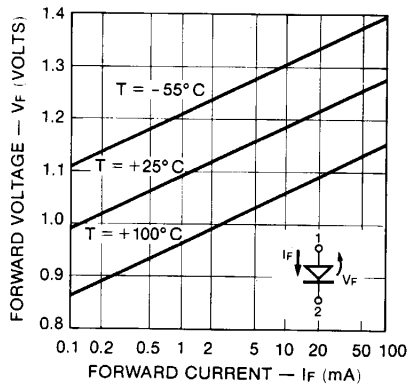

Fig. 1. Forward Voltage vs. Current

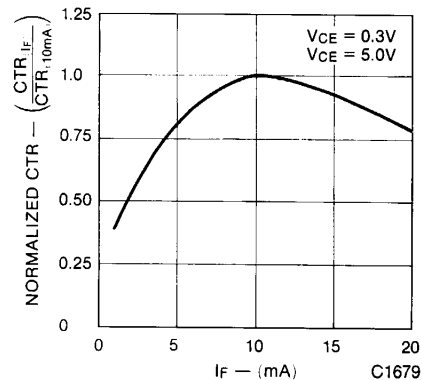

Fig. 2. Normalized CTR vs. Forward Current

ELECTRICAL CHARACTERISTIC CURVES
(25°C Free Air Temperature Unless Otherwise Specified) (Cont'd)

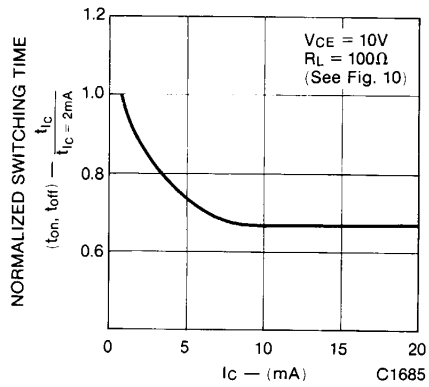

Fig. 5. Switching Time vs. IC

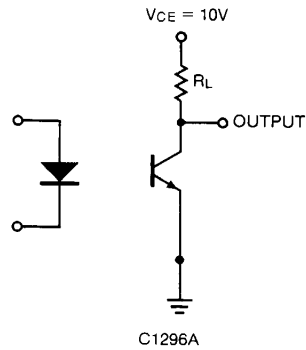

Fig. 6. Switching Time Test Circuit

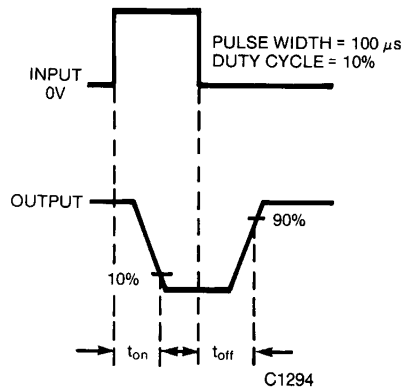

Fig. 7. Switching Time Waveforms

This datasheet has been download from:

www.datasheetcatalog.com

Datasheets for electronics components.